

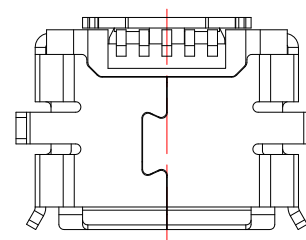

MRUSB-5B-D11x-S267

SHELL 鍍層:

TN
NI

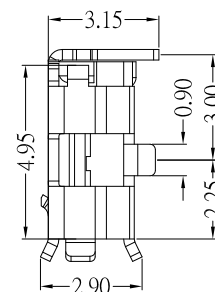
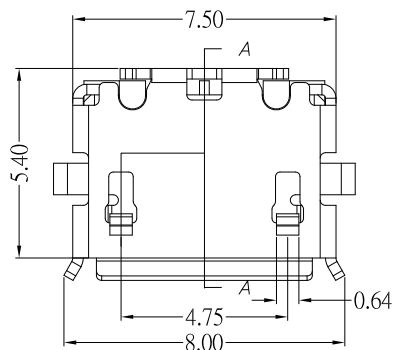
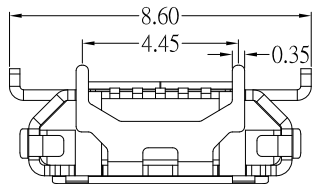

NOTES:

- MATERIAL:
 - HOUSING: LCP,UL94V-0
 - CONTACT: PHOSPHOR BRONZE
 - SHELL: BRASS
- Finish:
 - Contact: Plated Gold in Mating Area ;
Gold Plated on Solder Balls ;
Nickel under plated overall
 - SHELL: NICKEL or TIN UNDER PLATED SURFACE LAYER
- SPECIFICATION:
 - CURRENT RATING: PIN1,5--- 1.2 A Max
PIN2,3,4--- 1.0 A Max
 - DIELECTRIC WITHSTANDING VOLTAGE: 100 V(ac) FOR 1min
 - CONTACT RESISTANCE: 30 mΩ MAX.
 - INSULATION RESISTANCE: 100 MΩ MIN.
 - TOTAL MATING FORCE: 3.57 Kgf MAX.
 - TOTAL UNMATING FORCE: 1.0 Kgf MIN.
 - LIFE: 10,000 CYCLES
 - TEMPERATURE RANGE: -30°C ~ +80°C

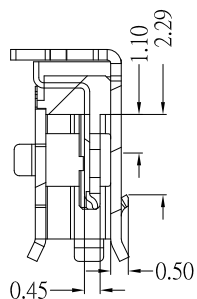

SECTION A-A

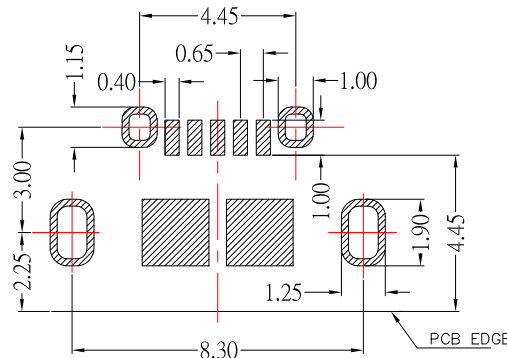
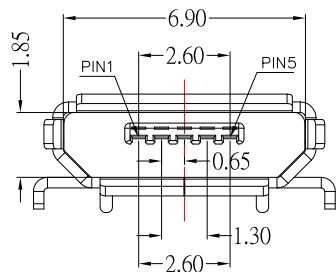
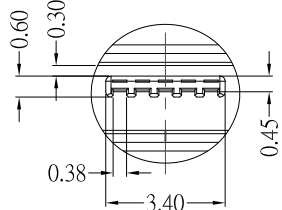

P.C.B LAYOUT MOUNTING PATTERN

東莞市高迪電子有限公司
DONG GUAN GAO DI ELECTRONICS CO., LTD

TOLERANCE UNLESS OTHERWISE STATED:
 Up to 5 ±0.2
 Above 5 ~ 15 ±0.3
 Above 15 ~ 30 ±0.4
 Above 30 ~ 50 ±0.5
 Angle ±0.3

3RD. ANGEL'S



UNITS MM

DRAWN BY: Jack Lu
 CHECKED BY: Jacky Chen
 APPROVED BY: Tony Kao

DATE: 02/10/15
 DATE: 02/10/15
 DATE: 02/10/15

MAT'L		TITLE	CONNECTOR
FINISH		MODLE	MICRO USB 5S B TYPE 牛角型
SCALE	1 : 1	DWG NO.	MRUSB-5B-D11x-S267
SHEET NO.	1 of 1	PART NO.	MRUSB-5B-D11x-S267

SIZE: A4
 VER: A0

1	更新為A0版	Jack	021015
ITEM NO.	DESCRIPTION	DRAWN	DATE